

8 7 6 5 4 3 2 1

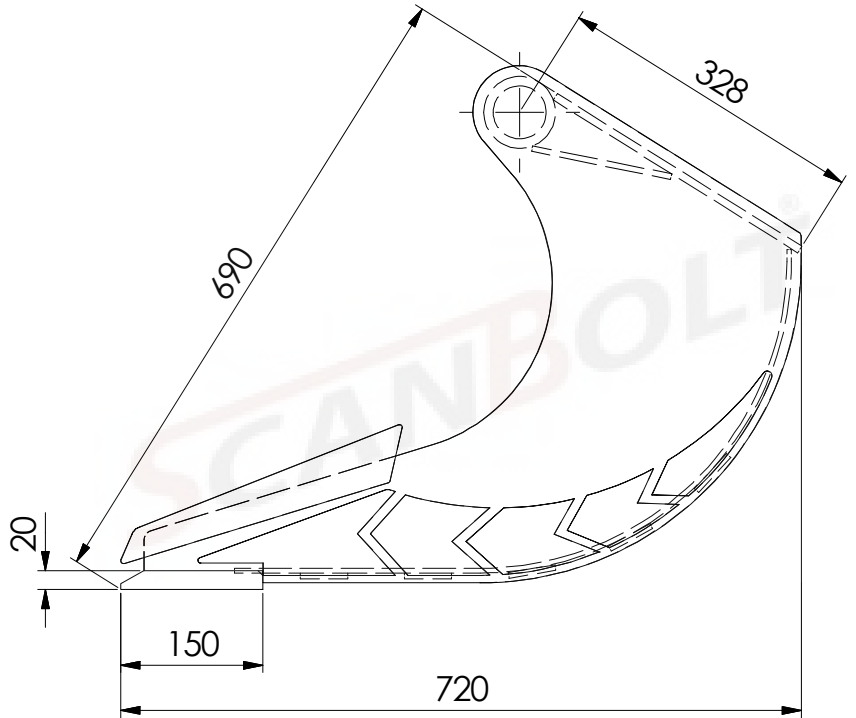
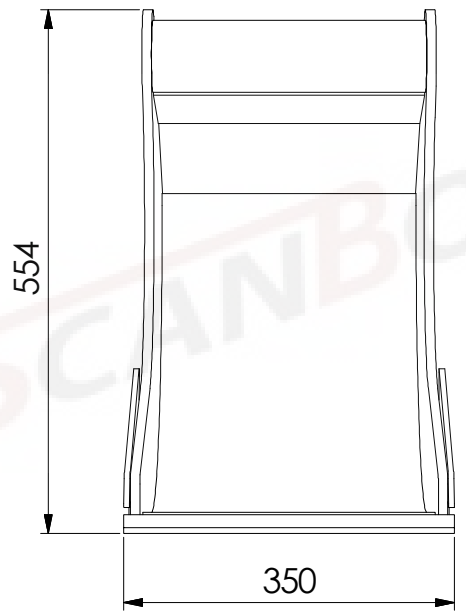
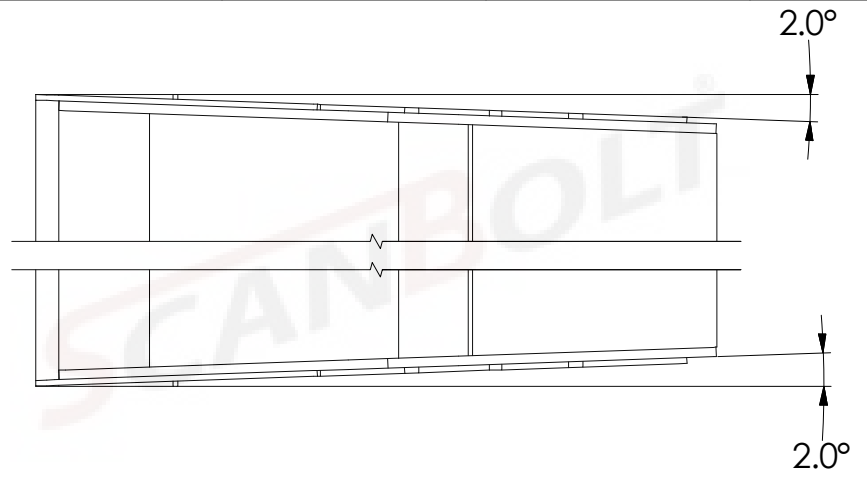
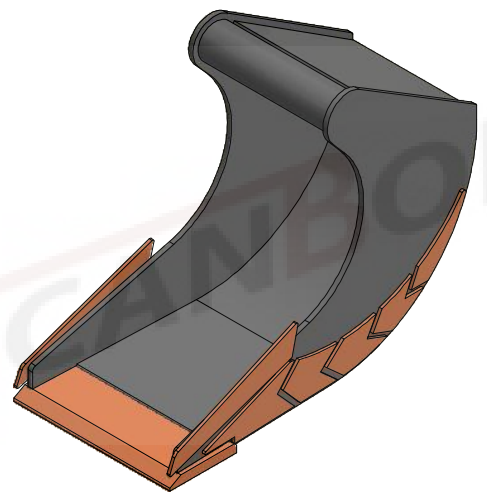

MATERIAL SPECIFICATION

ST52.3
EN8D
HB 400
HB 450
CASTALLOY STEEL

SCANBOLT®

DESCRIPTION	35 CM CLAY BUCKET
MACHINE CLASS	3.5 - 4.9 TON
WEIGHT	62 Kg
HEAPED CAPACITY	72 LITERS

8 7 6 5 4 3 2 1